

habitat

Globe bulb black ceiling light

1233797

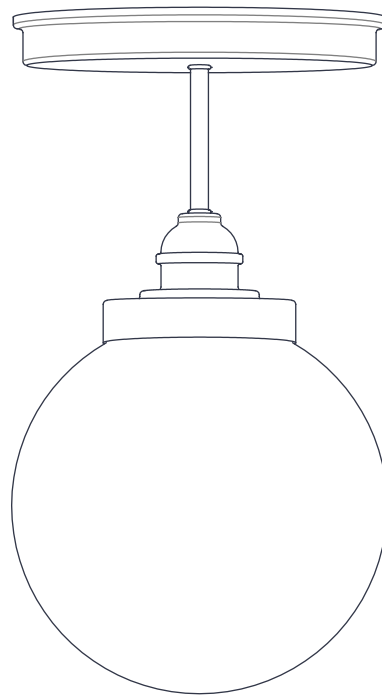

Dimensions

Width-19.5cm

Depth-19.5cm

Height-34cm

Care & Instruction Manual

For household and indoor use only

Please read and retain these instructions for future reference

Important

- For your safety, this product must be installed in accordance with wiring regulations from the Institute of Engineering and Technology (IET) and current local Building Regulations.
- If in any doubt, or where required by the law, consult a competent person who is registered with an electrical self-certification scheme. Further information is available online or from your Local Authority.
- To prevent electrocution, switch off at the mains supply before installing or maintaining this fitting. Ensure other persons cannot restore the electricity, supply without your knowledge.
- To avoid damage to concealed wiring during installation, establish the direction of the supply cable before drilling fixing holes.
- Always be sure to use the correct type and wattage of bulbs as indicated on the fitting. Never exceed the wattage stated.
- When changing the bulb, always switch off at the mains and allow the old bulb to cool down before handling. Dispose of used bulbs carefully.
- This fitting is Class II appliance.
- The luminaire is designed for indoor use only.

Instruction for use

Before removing the existing fitting, carefully note the position of each set of cables. If there are loop in cables that are not connected to the light, they must be terminated separately and not connected to the fitting.

1. Switch off the electricity supply at the fuse board.
2. Unscrew the two side screws to remove bracket from the ceiling plate .(Fig. 1a)
3. Using the bracket as a template, mark and drill fixing holes in the ceiling .Screw the bracket onto the ceiling using suitable screws. (Fig. 1b)
4. Each L, N and Earth cables should be fully covered by the small sleeving (provided); then fasten by using the plastic belt (provided) to make sure the small sleeving are fixed well on the cables. (Fig. 2)
5. Ensure the electrical connections are covered with suitable insulation tape.
6. Connect the supply wires to the terminal block in the corresponding L / N / E positions . (Fig. 3)
7. Offer fitting up onto the bracket and push any excess cable into the ceiling void. Secure the ceiling cup into position using the 2 screws removed earlier. Take care not to trap or damage wiring.
8. Fit the bulb to the lamp holder. The type and wattage is indicated on the fitting. The wattage indicated must not be exceeded.
9. Install the glass shade on the lamp holder.(Fig. 4)
10. Switch on the electricity supply at the fuse board.

- **IMPORTANT:** To avoid overheating, do not exceed the maximum wattage as stated on the product.

Maintenance

This luminaire is designed for indoor use only . Do not use polish or abrasive cleaner - use a soft dry cloth to clean the product.

1. Switch off the mains power supply.
2. Before replacing the bulb, allow it to cool down for at least 10 minutes.
3. Never touch the bulb with your fingers directly, cover it with a cloth.
4. Loosen the bulb and remove it from the lamp.
5. Replace a new bulb with same voltage and wattage (LED Max.8W) .Products should not be disposed of with household waste. Please recycle where facilities exist. Check with your local authority for recycling advice.

Fig. 1

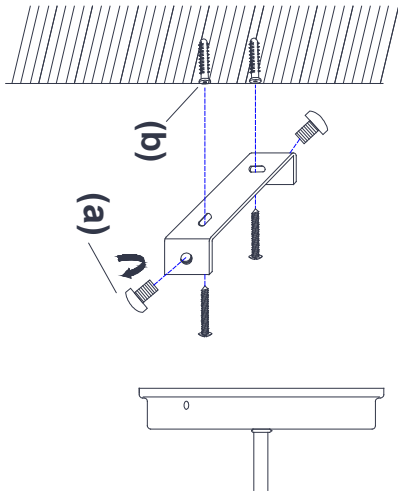

Screw & Plugs x 2

(Included in pack)

Sleeving x2 & plastic belt x1

(Included in pack)

Fig. 2

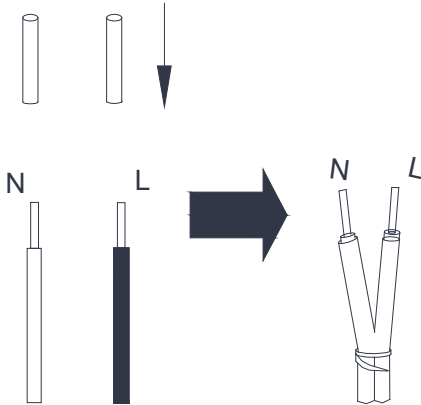

Fig. 3

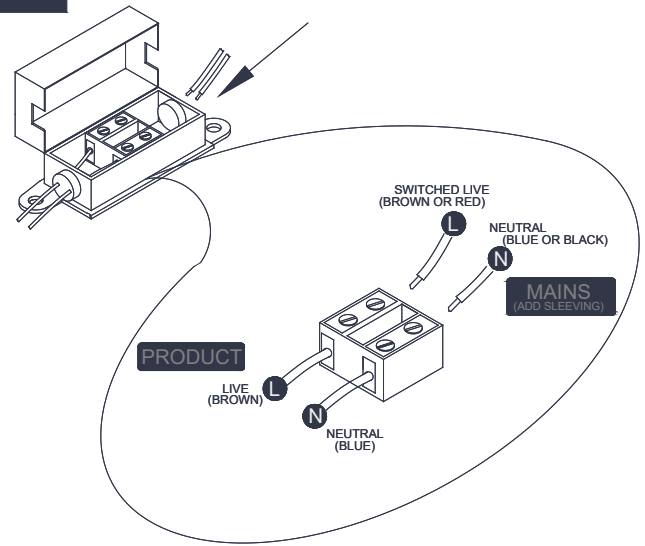
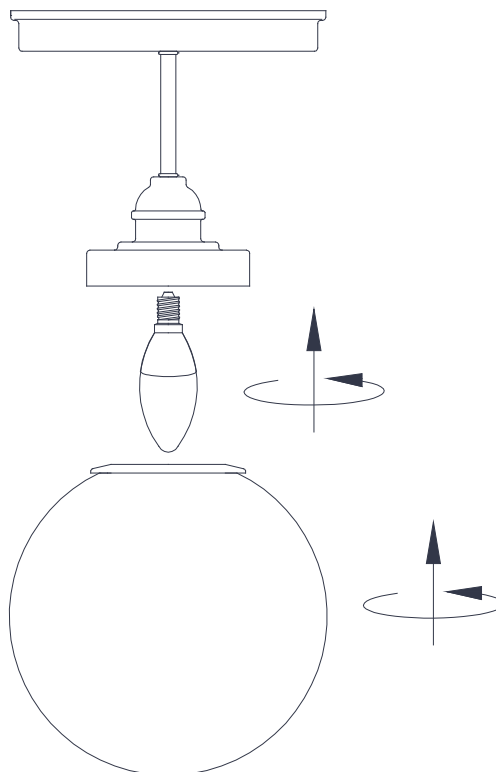
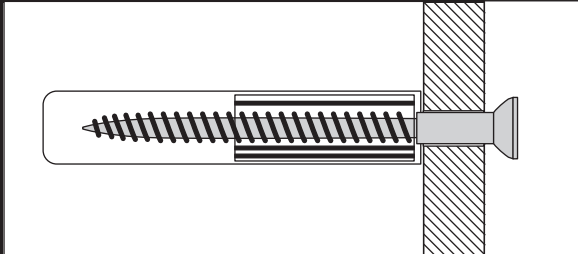

Fig. 4



Wall Mounting & Fixings



IMPORTANT:

When drilling into walls always check that there are no hidden wires or pipes etc. Make sure that the screws and wall plugs being used are suitable for supporting your unit. Consult a qualified tradesperson if you are unsure.

HINTS:

- 1) General Rule  Always use a larger screw and wall plug if you are not sure.
- 2) Ensure you use the recommended drill bit to match the wall plug and hole size.
- 3) Ensure you drill the hole horizontally, do not force the drill or enlarge the hole.
- 4) Take extra care when drilling high walls, ceilings and ceramic tiles. Ensure the plug is fitting below the ceramic tile to avoid splitting or cracking.
- 5) Ensure wall plugs are well fitted and are a tight fit in the drilled hole.

Types Of Walls

You can use one of the following types of wall plug if your walls are made of brick, breeze block, concrete, stone, wood or plaster board.

No.1 "Standard" Wall Plug General Wall Materials

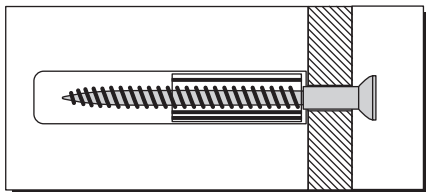

These come in various sizes and are made from plastic or sometimes wood fiber.

No.2 "General Purpose" Wall Plug Aerated / Breeze Block

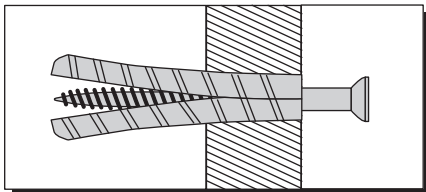

Generally aerated blocks should not be used to support heavy loads, use a specialist fitting in this case. For light loads, a General Purpose Plug can be used.

No.3 "Shield Anchor" Wall Plug Heavy Loads

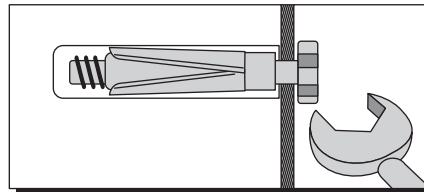

For use with heavier loads such as TV & HiFi Speakers and Satellite Dishes etc.

No.4 "Cavity Fixing" Wall Plug

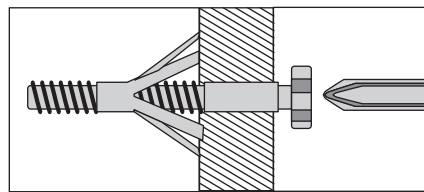

For use with plaster board partitions or hollow wooden doors.

No.5 "Cavity Fixing - Heavy Duty" Wall Plug

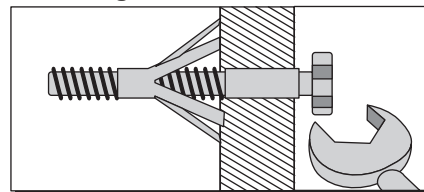

For use when fitting or supporting heavy loads such as shelving, wall cabinets, coat racks.

No.6 "Hammer Fixing" Wall Plug

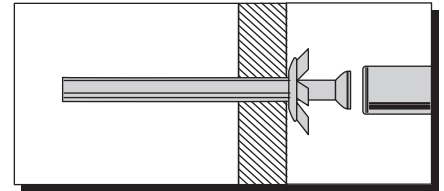

For use with walls stuck with plaster board. The hammer fixing allows it to be fixed to the wall rather than the plaster board. Always check the fixing is secure to the retaining wall.

CARE & MAINTENANCE

SAFETY

Always check the fitting and location to ensure your safety in and around the home.

FITTING

From time to time check the fitting to ensure the wall plugs or screws do not become loose.



Recycling electrical products

You should now recycle your waste electrical goods and in doing so help the environment. This symbol means an electrical product should not be disposed of with normal household waste. Please ensure it is taken to a suitable facility for disposal.

Visit www.recycle-more.co.uk, click on "bank locator" and enter your postcode to find your nearest recycling site.



<p>We care about our quality and what you think, If you have any comments, good and bad, Please call our Careline 0345 640 2020 Or visit Habitat.co.uk Your statutory rights are not affected.</p>	<p>Made in China for Habitat. Argos limited, 489-499 Avebury Boulevard, Milton Keynes, MK9 2NW. <u>Argos(N.I.)Ltd, Forestside Shopping Centre, Upper Galwally, Belfast, United Kingdom. BT8 6FX.</u> Argos Distributors (Ireland) Limited, Unit 7, Ashbourne Retail Park, Ballybin Road, Ashbourne, County Meath, Ireland.</p>
---	--