

# Antigua-bench

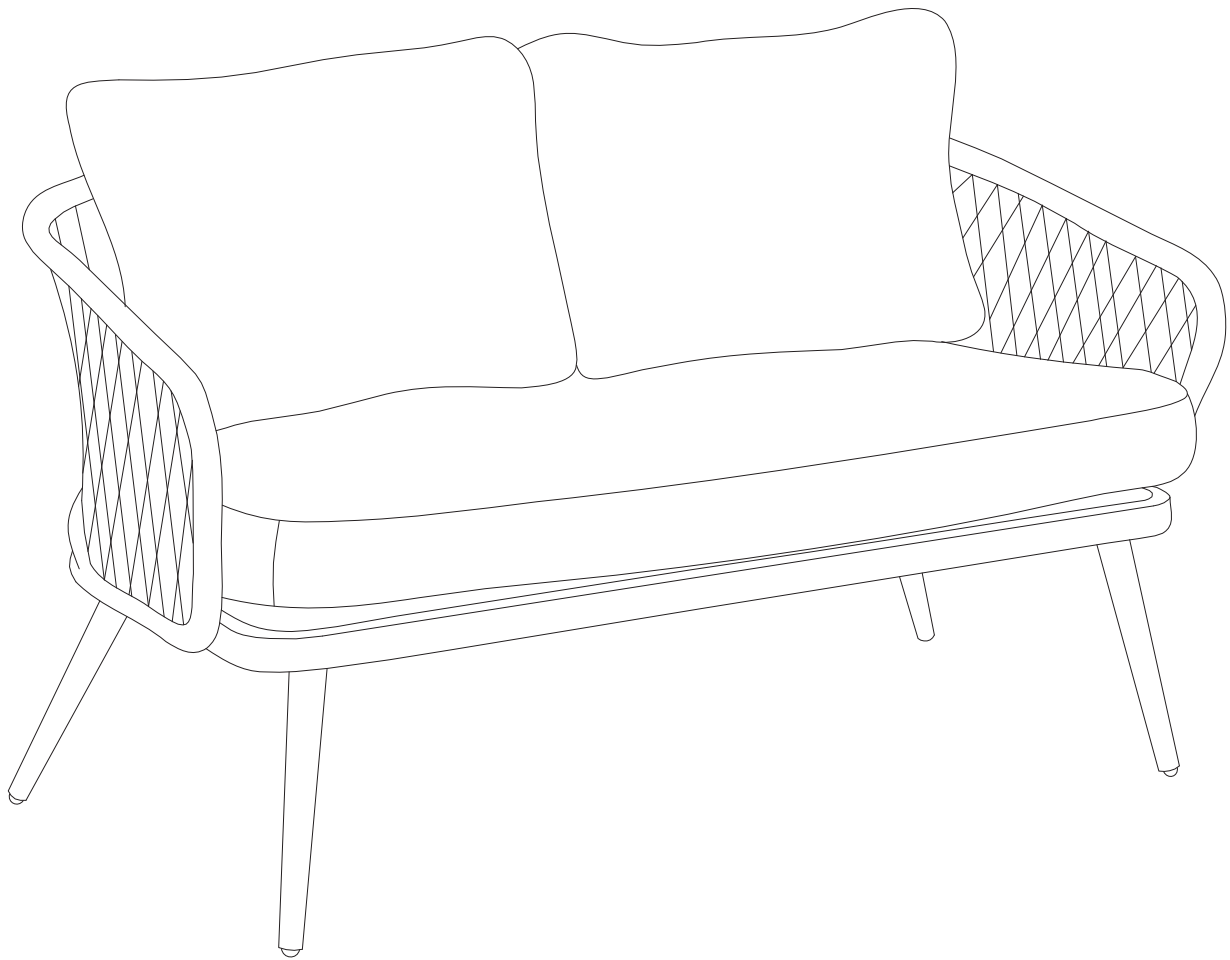

## Spare Parts

 [www.argos-support.co.uk](http://www.argos-support.co.uk)

 [Help@ClickSpares.co.uk](mailto:Help@ClickSpares.co.uk)

 0370 112 1928

## Customer Support

 0345 640 2020



# Safety and Care Advice

---

## Product Details

118/7805

### IMPORTANT, RETAIN FOR FUTURE REFERENCE: READ CAREFULLY.

- Keep children and animals away from the work area, small parts could choke if swallowed.
- Make sure you have enough space to layout the parts before starting.
- This product has been constructed to be used in the domestic environment only and not for commercial purposes.
- Assemble the item as close to its final position (in the same room) as possible.
- Assemble on a soft level surface to avoid damaging the unit or your floor.
- We do not recommend the use of power drill/drivers for inserting screws as this could damage the unit. Only use hand screwdrivers.
- Parts of the assembly will be easier with 2 people.
- Dispose of all packaging carefully and responsibly.

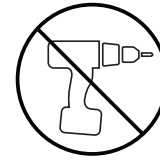

## Care and maintenance

---

- Only clean using a damp cloth and mild detergent, do not use bleach or abrasive cleaners.
- Use a dry cloth to clean the product, furniture polish is not recommended.
- From time to time check that there are no loose screws, nuts or bolts. If there are please re-tighten.
- This product should not be discarded with household waste. Take to your local authority waste disposal centre.

## Additional Guidance

---

- Assemble all parts and bolts loosely during assembly, only once the product is complete should you fully tighten the bolts.
- Regularly check and ensure that all bolts and fittings are tightened properly.
- Maximum user weight 220kg
- This product is compliant BS EN581-1; BS EN581-2

Produced in China. Sainsbury's Supermarkets Ltd. 33 Holborn, London, EC1N 2HT. Sainsbury's (NI) Ltd, Forestside Shopping Centre, Upper Galwally, Belfast, United Kingdom, BT8 6FX. Argos Limited, 489-499 Avebury Boulevard, Milton Keynes, MK9 2NW. Argos (N.I.) Ltd, Forestside Shopping Centre, Upper Galwally, Belfast, United Kingdom, BT8 6FX. Argos Distributors (Ireland) Limited, Unit 7, Ashbourne Retail Park, Ballybin Road, Ashbourne, County Meath, Ireland.

# Fittings (Shown to scale)

---

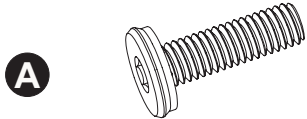

**A**

M6 x 20mm Screw x 12



**B**

Metal washer x 12

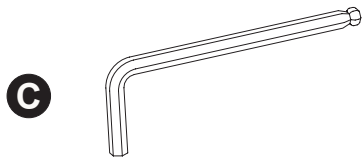

**C**

Allen key x 1

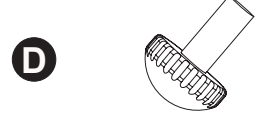

**D**

Adjustable cap x 4  
(assembled)

# Components - Parts

---

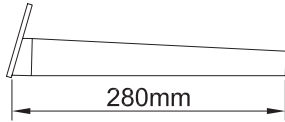

2 Front leg x 2

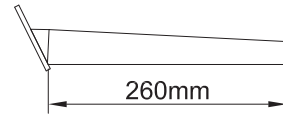

3 Back leg x 2

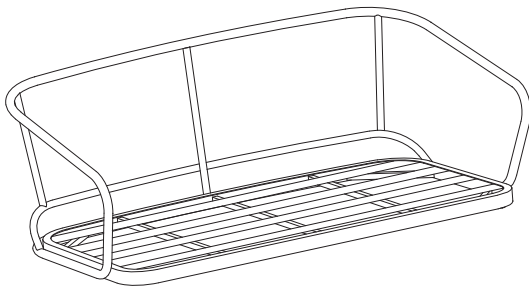

6 Seat frame x 1

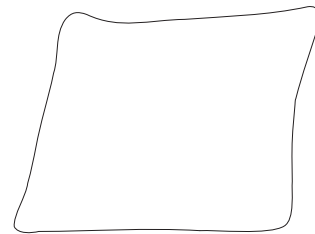

7 Back cushion x 2

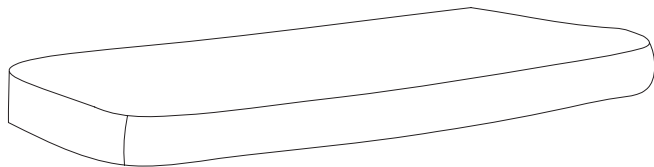

8 Seat cushion x 1

# 1

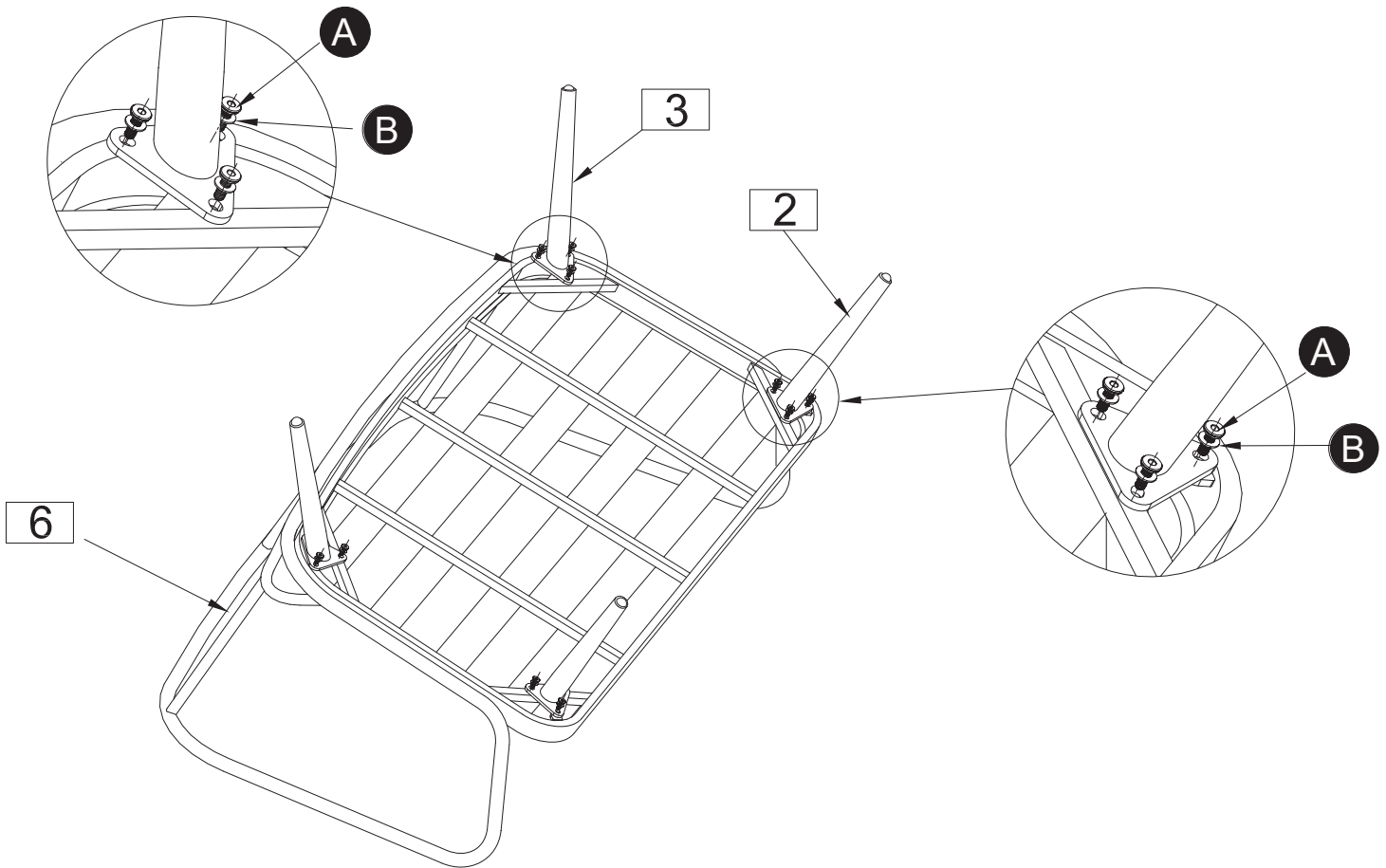
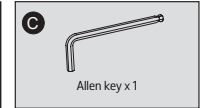
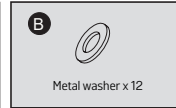
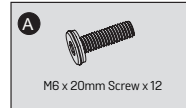
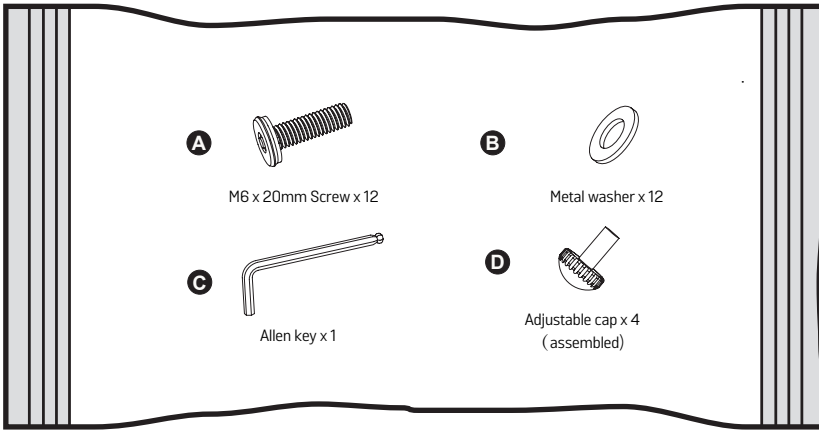

 Repeat x4

Important:  
Do not fully tighten all screws until assembly is complete.

# 2

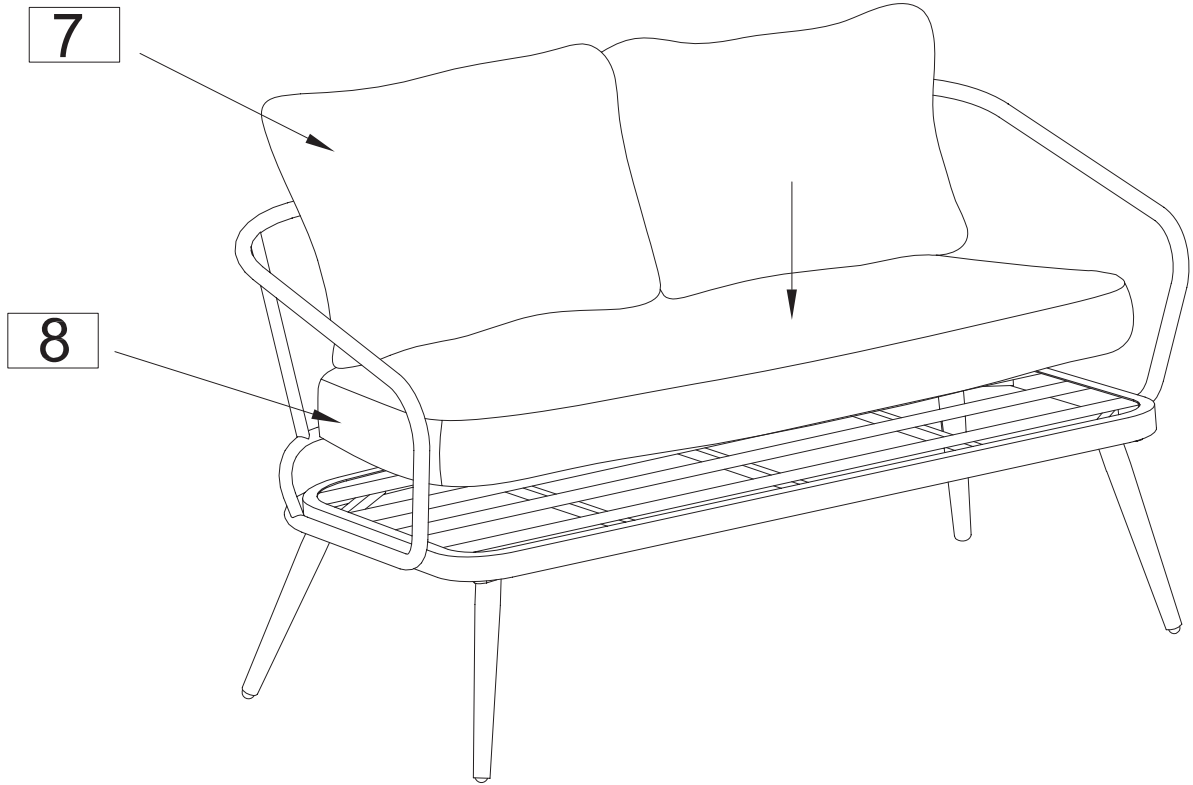

# 3

