

Components

A 2x Seat plate



B 1x Gas lift
60MM



C 1x Base
D550MM

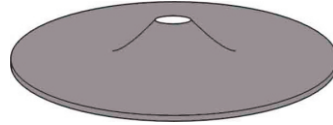

D 1x Gas lift
120MM



E 1x Base
D390MM



F 1x Footrest

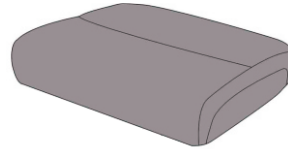

G 1 x Seat



Fittings

A 1 x Spanner
M6



B 8x Screw
M8*25MM



Costa Swivel Chair

Simple Assembly Instructions - Please keep for future reference

6893307
6893297
6917025

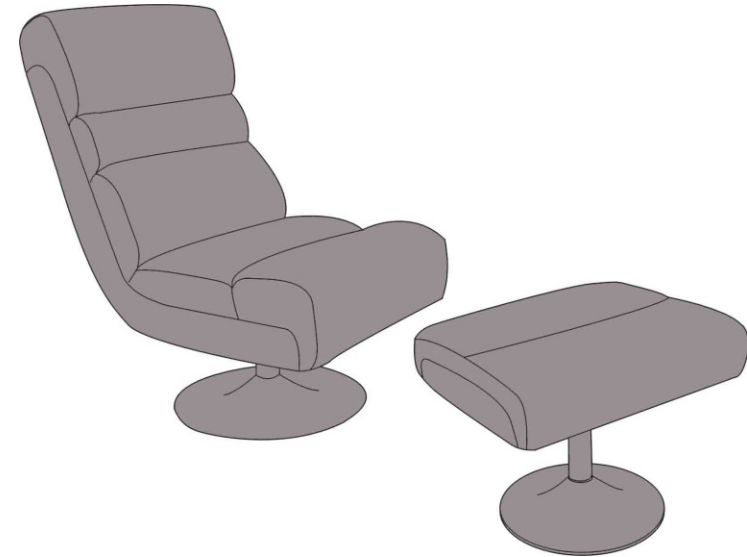

IMPORTANT

1. Read these instructions carefully and familiarise yourself with the procedure before assembling the unit.
2. Check that you have all the component parts following the list on the back cover and familiarise yourself with each part before proceeding.
3. Take all the fittings out of the plastic bag and separate them into their groups.
4. Ensure you have enough space to lay out all the parts before assembly.
5. To avoid scratching it is recommended that you assemble the unit on a soft level surface.

Assembly Instructions

Stage 1 - Fitting the chair

NOTE: It would be useful to ask someone to help you at this stage.

1. Fix the seat plate **A** with screws **B**.
See fig.1.

2. Insert the gas lift **B** into the base **C**.
See fig.2.

3. Carefully locate the seat onto the base unit.

4. Fix the seat plate **A** with screws **B**.
See fig.3.

2. Insert the gas lift **D** into the base **E**.
See fig.4.

3. Carefully locate the foot stool onto the base unit.

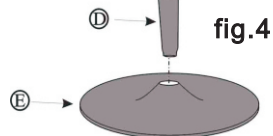
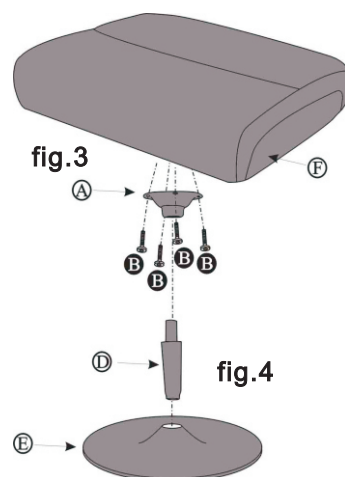
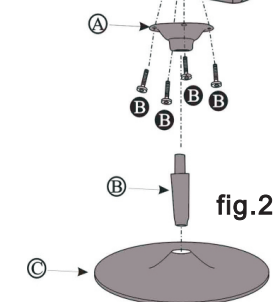
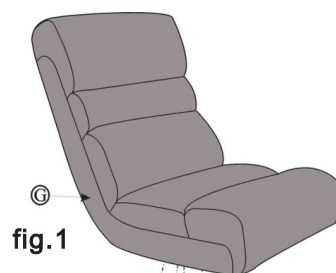

Assembly Instructions

Stage 2 - Finishing the unit

Carefully place the unit in the desired location.



fig.5

Care and Maintenance

Safety

To avoid any risk of suffocation to animals or children dispose of the plastic bags immediately.

Cleaning

As with all surfaces clean with a damp cloth and mild detergent, do not use bleach or abrasive products.

Fitting

From time to time please ensure there are no loose screws on the product.