

Dining Chair

Assembly Instructions - Please keep for future reference

600/6479

600/6486

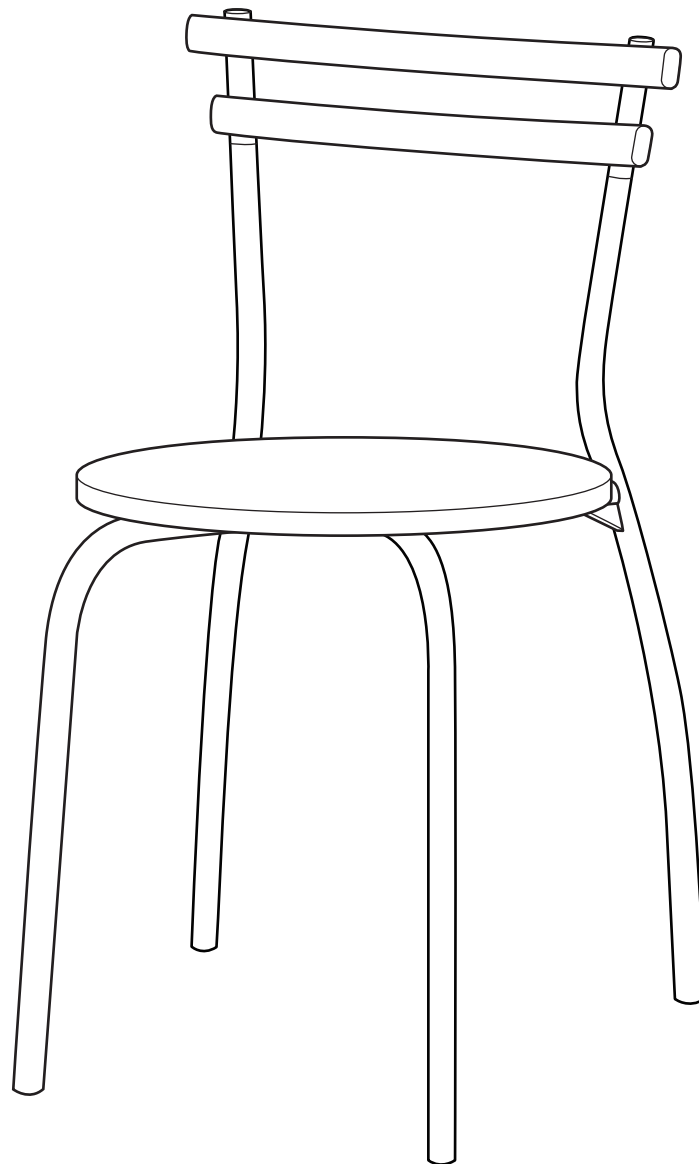

Dimensions

Width - 44.5cm

Depth - 42cm

Height - 77cm

Important - Please read these instructions fully before starting assembly

If you need help or have damaged or missing parts, call the **Customer Helpline: 08456 400800**



Safety and Care Advice

Important - Please read these instructions fully before starting assembly

- Do not discard any of the packaging until you have checked that you have all the parts and the pack of fittings.
- Discard all extra fittings and keep fittings out of reach of children.
- At least 2 people are required to assemble this product.
- Assemble this product on a flat surface.

- Assemble all parts loosely before tightening any bolts.
- Unit weight: 3.5kgs.
- Maximum safe weight of user: 110kgs.
- Retain Assembly Instructions for future reference.
- Dispose of all packaging carefully and responsibly.



- We do not recommend the use of power drill/drivers **for inserting screws**, as this could damage the unit. Only use hand screwdrivers.

Warnings

- This product should only be used on firm, level ground.
- Make sure the legs remain in contact with the ground.
- Do not stand on the product.

Care and maintenance

- Please clean the table surface using either damp (not wet) cloth and a mild domestic soap solution or by using an appropriate polish.
- Do not use any abrasive materials when cleaning.
- From time to time check that there are no loose bolts on this unit.

Components - Parts

If you have damaged or missing components, call the **Customer Helpline: 08456 400800**

Please check you have all the parts listed below

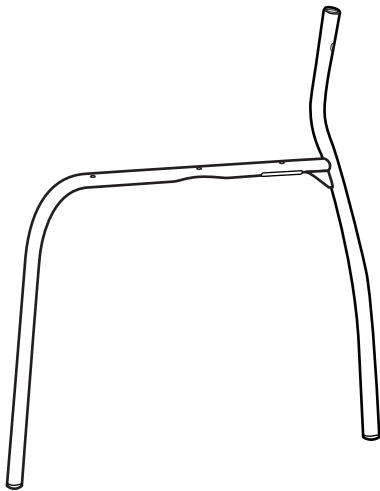

1 Upper leg
(67.5 x 56 x Ø2.2cm)

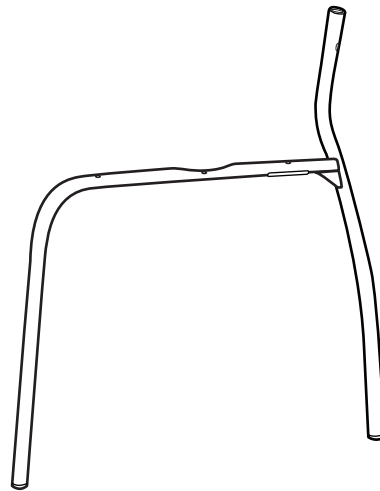

2 Lower leg
(67.5 x 56 x Ø2.2cm)

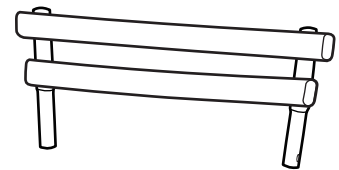

3 Backrest
(38.5 x 15 x 4.5 x Ø2.2cm)



4 Seat
(38 x 38 x 1.5cm)

Components - Fittings

Please check you have all the fittings listed below

Note: The quantities below are the correct amount to complete the assembly. In some cases more fittings may be supplied than are required.

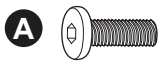

M6 x 12mm Bolt x 2

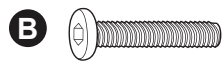

M6 x 30mm Bolt x 2

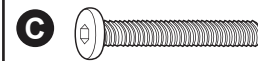

M6 x 32mm Bolt x 3



Allen key x 1

Ruler - Use this ruler to help correctly identify the screws

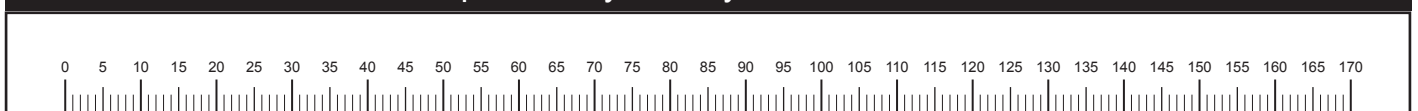

Assembly Instructions

Step 1

Attaching backrest

Position the upper leg **1** and lower leg **2** in a crossed position as shown.

With the help of an assistant holding the legs, insert the backrest **3** into holes on the legs as shown.

Then fix through holes using bolts **A** and tighten with allen key **D**.



Important:

Do not fully tighten the bolts at this stage.

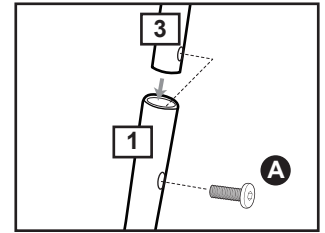
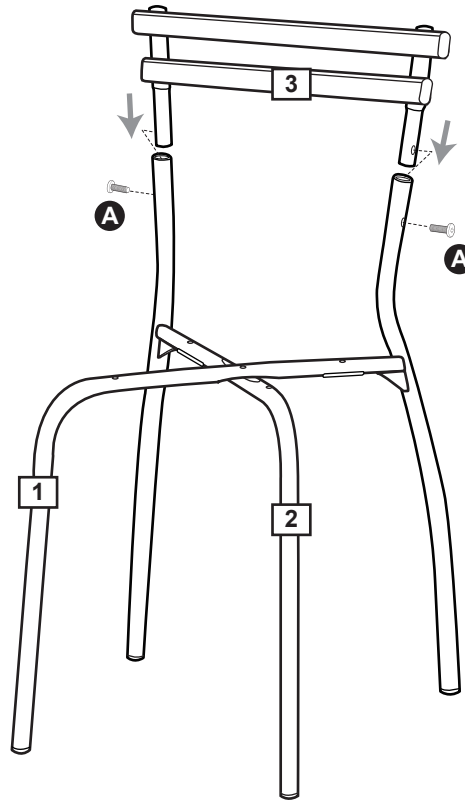

Step 2

Attaching seat

Place the seat **4** face down on a flat and raised surface.

Position the chair frame on the seat **4** as shown then fix through holes using bolts **B** & **C** then tighten with allen key **D**.



Important:

Carefully turn over the chair. Place it on a flat even surface and make adjustments to ensure the legs are even on the floor.

Then fully tighten bolts **A** fixed on step 1 using allen key **D**.

Assembly is complete.

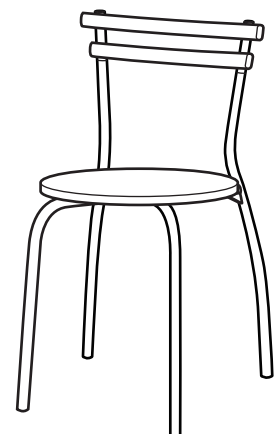
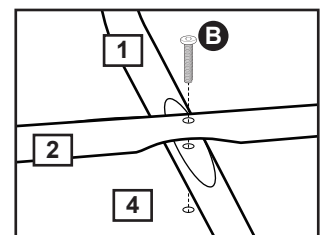
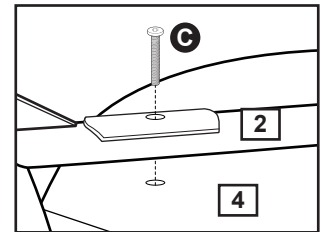
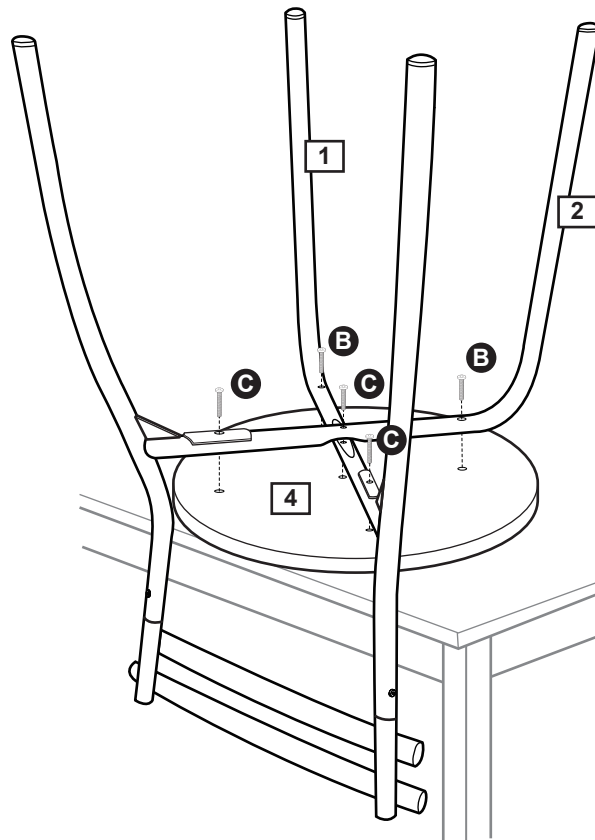

If you need help or have damaged or missing parts, call the **Customer Helpline: 08456 400800**