

George Foreman Fat Reducing Grill



instructions and
recipes

£10,000 prize draw
EXTRA year guarantee
FREE rewards gallery

www.productregister.co.uk/rhobbs
Register online now!
See back for
details

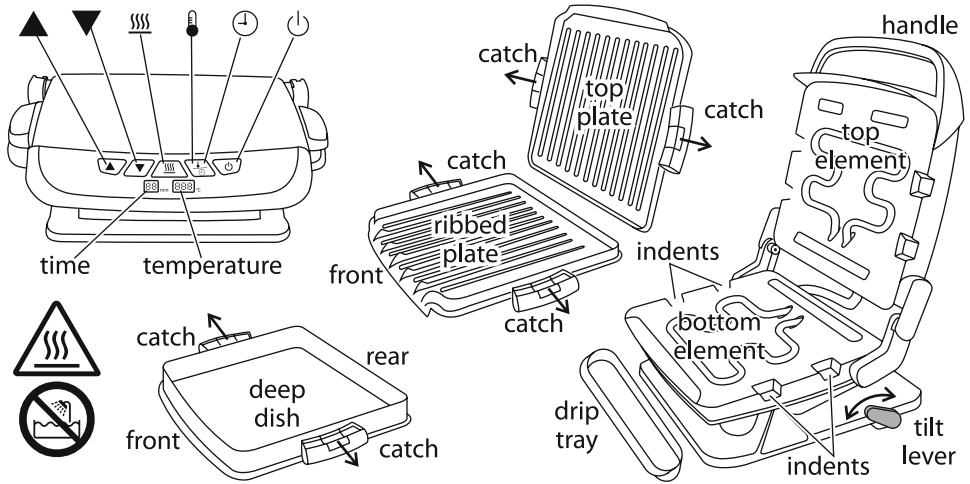

Read the instructions, keep them safe, pass them on if you pass the grill on.
Remove all packaging before use.

STOP IMPORTANT SAFEGUARDS

Follow basic safety precautions, including:

- 1 This appliance can be used by children aged from 8 years and above and persons with reduced physical, sensory or mental capabilities or lack of experience and knowledge if they have been supervised/instructed and understand the hazards involved.
 - Children shall not play with the appliance.
 - Cleaning and user maintenance shall not be done by children unless they are older than 8 and supervised.
 - Keep the appliance and cable out of reach of children under 8.
- 2 Don't connect the appliance via a timer or remote control system.
- ⚠ The surfaces of the appliance will get hot.
- 3 If the cable is damaged, return the appliance, to avoid hazard.
- ⊘ Don't put the grill in liquid, don't use it in a bathroom, near water, or outdoors.
- 4 Don't wrap food in plastic film, polythene bags, or metal foil. You'll damage the grill and you may cause a fire hazard.
- 5 Don't use the grill for any purpose other than cooking food.
- 6 Don't use the grill if it's damaged or malfunctions.

household use only

🔧 BEFORE USING FOR THE FIRST TIME



Wipe the grill plates with a damp cloth.

👁 THE GRILL PLATES





- top plate** this must be fitted to the top element whenever the grill is used
- ribbed plate** to grill meat, sausages, and anything that might give off fat
- deep dish** non-fatty items, baking, things like eggs, omelettes, pancakes, pittas, calzone, and batters (like Yorkshire pudding) that need a flat surface

- 1 Fit the ribbed plate with the overhang at the front.
- 2 Fit the deep dish with the bowed edge at the front, and the straight edge at the rear.
- 3 Fit one plate at a time.
 - a) open the grill
 - b) slide the centre parts of the latches outwards (they're marked "RELEASE")
 - c) fit the plate over the element, with the latches over the indents
 - d) release the latches, to lock the plate in place
- 6 Remove one plate at a time.
 - a) open the grill
 - b) slide the centre upper parts of the latches outwards (they're marked "RELEASE")
 - c) lift the plate off the grill
- 7 Do you want the grill tilted, so that fat and juices run down to the drip tray, or flat, for eggs, pizza, and other "runny" foods?
 - a) turn the tilt lever forward to tilt the grill
 - b) turn the tilt lever towards the rear to use the grill flat
- 8 Close the grill

PREPARATION

- 9 Sit the grill on a stable, level, heat-resistant surface, away from cupboards, curtains, etc.
- 10 Centre the drip tray under the front of the grill, to catch run-off.
- 11 Wipe the grill plates with oil or butter. Don't use low fat spread – it may burn on to the grill.
- 12 Put the plug into the power socket (switch the socket on, if it's switchable).
- 13 Time will show --, temperature will show ---.
- 14 Press the  button.
- 15 The grill will beep, the  button will glow, the time display will show 5, and the temperature display will show 140, blinking.
 - The time display will start to count down – ignore it,

SET THE TEMPERATURE/PREHEAT THE GRILL

-  Don't touch the  button.
- 16 Press  to increase,  to reduce the temperature displayed.
 - 17 The range is from 140 to 215 (that's degrees Celsius), in 15 degree steps.
 - 18 The temperature display will blink while the grill is heating; it'll stop blinking when the temperature is reached, and beep 4 times.
 - 19 Wait till it stops blinking before filling the grill.

FILL THE GRILL

- 20 Use an oven glove to open the grill.
- 21 Lay the food on the bottom grill plate with a spatula or tongs, not fingers.
- 22 Close the grill. The hinge is articulated to cope with thick or oddly shaped foods.
- 23 The grill plates should be roughly parallel, to avoid uneven cooking.
- 24 Wait while the food cooks.

REMOVE THE FOOD

- 25 Use an oven glove to open the grill.
- 26 Check that the food is cooked. If you're in any doubt, cook it a bit more.
- 27 Use wooden or plastic tools to remove the food.











FINISHED?

- 28 Press , to switch off the elements, then unplug the grill.

MORE?

- 29 Use an oven glove. Empty the drip tray into a heatproof bowl, give it a wipe with kitchen paper, and replace it under the front of the grill.

USING THE TIMER

- * Using the timer is optional. It doesn't turn the grill off, it simply beeps 4 times to tell you the time is up.
- 30 Pressing  redirects the  and  buttons to control the time display.
- 31 If you press  again, the  and  buttons revert to controlling the temperature display.
- 32 Press  to increase,  to reduce the time displayed.
- * After 5 seconds of inaction, the appliance will revert to temperature mode.
- 33 The maximum is 20 minutes – it doesn't roll over after 20, use  to reduce it.
- 34 The timer will count down, beep 4 times, then show .
- * When it shows , it means exactly that – if you leave food on the grill, it'll keep on cooking. Make sure you remove the food as soon as it's ready.

USING THE SEAR FUNCTION

- * Using the sear function gives you 90 seconds at 250°C.
- 35 This is best used with close-grained red muscle tissue like beef/buffalo/bison, lamb/sheep/goat, venison, swordfish, ostrich/emu, kangaroo, cut as steaks (across the grain of the meat).
- 36 The steaks should be between 5mm and 25mm ($\frac{3}{16}$ to 1 inch) thick.
- 37 You'll need the oven glove, and non-metal tongs.
- 38 Press the  button – the button will glow, the temperature display will show 250, blinking.
- 39 Wait till the grill beeps 4 times (the display stops blinking).
- 40 Open the grill, lay the food on the bottom grill plate, then close the grill.
- 41 Wait till the grill beeps again (90 seconds), when it will revert to the default temperature.
- 42 The outside surfaces of the food will be seared to a deep brown, while the inside should still be rare to medium rare, depending on the thickness of the food.
- 43 You now have the option of removing the food right away, for rare or medium, or leaving it to cook at the default temperature for a little longer, if you want the meat more well done.
- * If you want to use the sear function again, wait 10 minutes before doing so.

CARE AND MAINTENANCE

- 44 Press , then unplug the grill and let it cool.
- 45 Wipe all surfaces with a damp cloth or sponge.
- 46 Use a paper towel with a dab of cooking oil to remove stubborn stains.
- 47 Wash the grill plates in warm soapy water, or in a dishwasher.
- 48 Wash the drip tray in warm soapy water, or in the top rack of the dishwasher.
- 49 Take extra care with the non-stick cooking surfaces.
- 50 Don't use harsh or abrasive cleaners, solvents, scourers, wire wool, or soap pads.
- 51 **George Foreman** sponges, designed specially for cleaning our grills, are available online.
- * Where the top and bottom plates make contact, the non-stick surfaces may show signs of wear. This is purely cosmetic, and will not affect the operation of the grill.

cooking times & food safety

Use these times purely as a guide. They're for fresh or fully defrosted food. When cooking frozen foods, add 2-3 minutes for seafood, and 3-6 minutes for meat and poultry, depending on the thickness and density of the food.

Check food is cooked through before serving. If in doubt, cook it a bit more.

Cook meat, poultry, and any derivatives (mince, burgers, etc.) till the juices run clear. Cook fish till the flesh is opaque throughout.

When cooking pre-packed foods, follow any guidelines on the package or label.

	min		min
beef		lamb	
fillet	5-7	kebabs, 25mm cube	7-8
loin steak	7-8	minced	6-7
burger, 50g	5-6	loin chops	4-6
burger, 100g	7-8	sandwiches	
burger, 200g	8-9	cheese	2-3
kebabs, 25mm cube	7-8	ham (cooked)	5-6
round steak	5-7	roast beef (cooked)	6-7
sausages (thin)	5-6	sausage (cooked)	6-7
sausages (thick)	7-8	turkey (cooked)	6-7
sirloin	7-9	seafood	
T-Bone	8-9	halibut steak, 12-25mm	6-8
fruit		kebabs, 25mm cube	4-6
apple, halve/slice	6-8	prawn	1-2
bananas, slice lengthwise	3-4	red snapper fillet	3-5
nectarines, halve/slice	3-5	salmon fillet	3-4
peaches, halve/slice	3-5	salmon steak, 12-25mm	6-8
pineapple, slice	3-7	scallops	4-6
pork		sea bass fillet	3-5
chops, 12mm	5-6	swordfish steak, 12-25mm	6-9
gammon steak	5-6	tuna steak, 12-25mm	6-8
kebabs, 25mm cube	7-8	snacks	
minced	7-8	calzone	8-9
sausages (thin)	5-6	hot dogs	2-3
sausages (thick)	7-8	quesadillas	2-3
tenderloin, 12mm	4-6	tacos, meat filling	6-8
chicken/turkey		vegetables	
chicken breast pieces	5-7	asparagus	3-4
burger, 50g, fresh	4	carrots, sliced	5-7
burger, 50g, frozen	5	aubergine, slice/cube	8-9
burger, 100g, fresh	5	onions, thin slice	5-6
burger, 100g, frozen	6	peppers, thin slice	6-8
kebabs, 25mm cube	7-8	peppers, grill then skin	2-3
thighs (chicken)	5-7	whole peppers brushed with oil	8
minced	7-8	potatoes, slice/cube	7-9
turkey breast, thin sliced	3-4	squash, slice/cube	6-8

a few recipes to get you started

- Oil the plates, preheat the grill, then cook at 200 or above (unless the recipe says otherwise).
- When times are shown as a range (e.g. 5-7 minutes), we suggest you cook for the minimum time, then start checking the food for readiness.

top plate and ribbed plate (grill tilted)

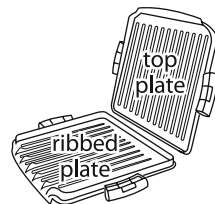

sausage and herb stuffed pork

serves a family of 4

- 250g/½lb low-fat sausage, uncooked
- ½ cup fresh breadcrumbs
- 2 tbsp fresh parsley
- ½ tsp thyme
- ½ tsp marjoram
- 1 tsp fresh ground black pepper
- 2 whole pork tenderloins (fillets)
- 8 cocktail sticks, soaked in water then patted dry

Remove the sausage skins. Mix the sausagemeat, marjoram, thyme, parsley, and pepper in a bowl. Cut each tenderloin in two, then cut a slit sideways into each piece to make a pocket. Stuff the pockets with the mixture, and fasten the edges with cocktail sticks. Grill till the pork and stuffing are cooked through (6-8 minutes).



chicken tandoori with yogurt-based marinade

- 2 boneless, skinless chicken breasts
- 200-250g carton plain low-fat yogurt
- 1 tbsp lemon juice
- 2 tsp paprika
- 2 garlic cloves, minced
- ½ tsp ground ginger
- ½ tsp cumin
- ½ tsp cayenne pepper
- ½ tsp cinnamon

Use a lidded casserole dish big enough to hold everything. Mix the yogurt, lemon juice, paprika, garlic, ginger, cumin, cayenne and cinnamon in the dish. Cut each chicken breast into two, add them to the dish, and turn till they're well coated. Cover and refrigerate for 1-8 hours, turning at least every hour. Grill the chicken till it's cooked through (5-7 minutes). Discard the marinade.

serves a family of 4

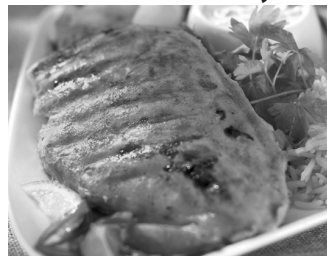

smoked mackerel panini with tomatoes and crème fraiche

serves 1

- 2 small cooked smoked mackerel fillets
- 2 thick slices wholegrain/wholewheat
- 4 cherry tomatoes, halved
- 1 large handful watercress

dressing

- 2 tbsp reduced fat crème fraiche
- ½ tsp lemon zest, grated
- squeeze lemon juice
- 1 tsp black pepper

Mix the dressing ingredients and refrigerate.

Flake the mackerel on a slice of bread, top with tomatoes and watercress, then the other slice, cook for 2-3 minutes, add the dressing, and serve.



Mediterranean beef and vegetable grill

- 500g/1lb hindquarter flank steak
- 1 small courgette, cut into 8 pieces
- 1 small tomato, cut into 8 pieces
- 1 small onion, cut into 8 pieces
- 1 green pepper, cut into 8 pieces
- 1 tbsp balsamic vinegar
- 1 tsp fresh ground black pepper
- 1 tsp garlic granules

8 wooden skewers, soaked in water then patted dry

Mix the vinegar, pepper and garlic granules in a bowl.

Freeze the steak for 30 minutes, then cut it into thin strips, across the grain. Discard any fat. Thread the steak on 4 skewers, and the tomato and vegetables on the other 4. Grill the steak skewers for 4 minutes, then add the vegetable skewers to the grill. Sprinkle the skewers with the vinegar, pepper and garlic mixture, and grill for 3-4 minutes more.

serves a family of 4



herbed chicken and mushroom kebabs

- 2 boneless, skinless chicken breasts
- 500g/1lb fresh whole mushrooms
- 1 tsp dried rosemary
- 1 tbsp dried parsley
- ½ tsp dried thyme
- ¼ cup lemon juice
- 2 tbsp white vinegar
- ½ cup nonfat chicken broth
- 1 tsp black pepper

8 wooden skewers, soaked in water then patted dry

Use a lidded casserole dish big enough to hold the chicken, mushrooms and marinade. Mix the rosemary, parsley, thyme, juice, vinegar, broth, salt and pepper in the dish. Cut the chicken

into 25mm/1" cubes, add to the dish, and turn till they're well coated. Add the mushrooms, and turn gently. Cover and refrigerate for 4-12 hours, turning occasionally. Thread the chicken and mushrooms on the skewers, and grill till cooked through (5-7 minutes). Discard the marinade.

serves 4



healthy pizza pitta pockets

- 2 slices lean ham or turkey (cooked)
- 50g/1½oz reduced fat mozzarella
- 2 wholemeal pitta breads
- 2 tomatoes, thinly sliced
- 2 mushrooms, thinly sliced
- ¼ small onion, thinly sliced
- 1 tbsp sweetcorn
- ¼ green pepper, diced
- 1 tbsp tomato purée
- 1 tsp olive oil
- 1 tsp dried mixed herbs

Slit open each pitta bread to form pockets, and spread the tomato purée inside each pocket. Cut the ham/turkey into strips, turn them in a bowl with the other ingredients, rest for half an hour to rehydrate the herbs, then fill the pitta pockets and grill for 3-5 minutes.

serves 2



goujons of fish with carrot sticks and sweet potato wedges

serves 2

- 1 large tuna, cod or salmon steak
- 1 medium carrot
- 1 small sweet potato
- 25g/1oz wholemeal flour
- 1 egg white
- breadcrumbs from 1 slice of wholemeal bread
- 1 tsp white pepper
- ½ tsp medium curry powder (optional)
- 1 tsp clear honey
- 1 tsp olive oil
- 1 tsp paprika



Put the olive oil in a bowl. Cut the sweet potato into thin wedges. Toss the wedges in the bowl to coat them with oil, then put them on a plate.

Stir the paprika and honey into the bowl. Cut the carrot into sticks about the same width as the thick ends of the potato wedges, and toss them in the bowl to coat them. Put the wedges and sticks on the grill, and cook for 4 minutes.

Mix the flour, curry powder and pepper on a plate. Put the egg white on another plate, and mix with a fork. Put the breadcrumbs on a third plate.

Cut the fish into goujons (fingers), and dip the fish goujons into the seasoned flour, then into the egg white, then the breadcrumbs.

When the wedges and sticks have cooked for 4 minutes, add the goujons to the grill, and cook for another 3-4 minutes, or till the breadcrumbs turn golden.

warm Asian-style noodle and tofu salad

serves 2

- 60g/2oz buckwheat or soba noodles
- 250g/8oz pre-cooked tofu, drained and cubed
- 1 carrot, peeled and grated into long strips
- 1 head pak choi, shredded
- ½ courgette, cut into long strips
- ½ red onion, cut into strips
- small handful fresh coriander leaves, torn

marinade

- 1 garlic clove, crushed
- 1 red chilli, de-seeded and finely chopped
- 2 tbsps reduced sodium soy sauce
- 1 tsp sweet chilli dipping sauce
- 1 tsp sesame oil
- juice of ½ lime



Combine the marinade ingredients in a bowl, add the tofu, and refrigerate overnight.

Boil two litres of water in a large pan, add the noodles, bring back to the boil, and boil for 10 minutes, drain, transfer to a serving dish, and keep warm.

Grill the marinated tofu till golden brown (2-3 minutes), then remove and set aside.

Grill the carrot, courgette, pak choi and onion for 30-60 seconds to wilt them.

Lay the wilted vegetables on the noodles, top with the grilled tofu, and garnish with the coriander and a squeeze of lime juice.

creamy cheesy chicken parcels with hidden green stuff

serves 2

- 1 lean skinless chicken breast
- 2 flour tortilla wraps
- 75-100g/2½-3oz reduced fat cream cheese
- 100g/3oz fresh baby spinach leaves
- 1 tsp mustard powder
- 1 tsp grated nutmeg
- 1 tsp pepper

Grill the chicken till it's cooked through (6-8 minutes). Remove it from the grill, let it cool, and cut it into strips. Wash and dry the spinach, wilt the leaves on the grill for 20-30 seconds, remove, and dry with kitchen paper. Mix the cream cheese and spinach in a bowl, then fold in the chicken strips.

Spoon the mixture into the centre of the tortilla wraps, fold one end of each wrap over, roll the wraps up, and warm the filled wraps on the grill for 2-3 minutes.



wholegrain panini with feta, red onions and red pepper

serves 1

- 2 thick slices wholegrain or wholewheat bread
- 50g reduced fat feta cheese
- ½ red onion, cut into thin strips
- ½ red pepper, cut into strips
- 2 tbsp balsamic vinegar
- ½ tsp fresh ground black pepper

Mix the onion, red pepper, balsamic vinegar and black pepper in a bowl. Spoon the mixture on to the grill, cook till softened (1-2 minutes), and lay it on a slice of bread. Tear the feta, sprinkle over the mixture, and top with the other slice of bread. Clean the grill, then grill the panini for 2-3 minutes. Serve with a watercress and tomato salad.



quick and easy grilled bananas

serves 2

- 2 bananas, peeled
- 2 tbsp walnuts, finely chopped
- 2 tbsp sugar
- ½ tsp cinnamon

Mix the walnuts, sugar and cinnamon in a bowl. Split the bananas lengthwise, then across their width. Lay the bananas on the grill, flat sides uppermost, and spoon the mixture on top of them. Grill till the bananas are warm and the cinnamon and walnuts are slightly glazed (3-4 minutes).



grilled strawberry maple shortcake

serves 4

- 1 low-fat shortcake, cut into 8 slices
- ¼ cup maple syrup
- 2 cups fresh strawberries, cleaned and sliced
- 1 cup non-fat whipped cream topping

Lay the shortcake pieces on the grill, brush with maple syrup, and grill for 3-5 minutes. Remove, top with strawberry slices and whipped cream topping.



vanilla fruit kebabs with a quick creamy dip

serves 4

- ½ fresh pineapple or a tin of pineapple chunks
- 1 small orange
- 2 bananas
- 2 peaches or nectarines
- 1 tsp brown sugar
- 4 tbsp orange juice
- 2 small tubs fruit fromage frais
- 1 tsp vanilla extract
- 8 wooden skewers, soaked in water then patted dry

Cut the fruit into chunks and marinade for 10 minutes in the orange juice, brown sugar, and half the vanilla extract.

Thread the marinated fruit chunks on the skewers, and grill for 4-6 minutes.

Mix the fromage frais with the other half of the vanilla extract as a dip for the kebabs.



the original burger

serves 4

- 500g/1lb lean minced beef
- 1 tbsp Worcestershire sauce
- 1 tsp black pepper
- 1 red onion
- 4 wholegrain burger buns
- tomato, lettuce, dill pickles, etc. to garnish

Combine the mince, Worcestershire sauce and pepper, and shape into 4 burgers.

Slice the onion into 12mm/½" thick slices.

Grill the burgers for 4 minutes, top each with an onion slice, then grill for 3-4 minutes more.

Serve the burgers on the buns with your choice of garnish (tomato, lettuce, dill pickles, etc.).



Santa Fé veggie-burger

serves 4

- 1 cup steamed white rice
- ½ cup of canned corn kernels
- 1 green pepper, seeded
- 1 large white onion
- 1 tsp fresh ground black pepper
- 1 tsp lemon juice
- 1 tsp chilli powder
- 4 wholegrain hamburger buns
- non-fat cooking spray

Use a blender or food processor to process the rice, corn, green pepper, onion, pepper, juice and chilli powder to a coarse, mealy texture.

Shape the mixture into 4 burgers and refrigerate for 2 hours.

Spray the grill lightly with non-fat cooking spray, grill the burgers till well browned (6-7 minutes), then serve in the buns.



chicken fillets with a Thai curry sauce

serves 4

- 4 large chicken fillets, trimmed of fat and skin
- 375g Thai curry sauce
- ½ cup coconut milk
- 2 spring onions, finely chopped
- ½ handful torn coriander leaves
- steamed jasmine rice or noodles mixed with grated lemon or lime peel
- additional ½ handful torn coriander leaves



Flatten the chicken fillets to an even thickness. Preheat the grill.

Lightly spray the grill plates with cooking oil.

Grill the chicken fillets till cooked (5-7 minutes).

Meantime, heat the sauce in a pan, stir in the coconut milk, spring onions and coriander leaves. Stir till cooked (don't let it boil).

Put a portion of sauce on a plate, lay a chicken fillet on the sauce, then put a little more sauce on top. Add the rice/noodles and torn coriander leaves, and serve with crisp green vegetables.

fillet steak with tomato concasse

serves 6

- 6 fillet steaks
- 1 clove garlic

tomato concasse

- 2 large onions, finely chopped
- 2 tbsp olive oil
- 450g tin of tomatoes, drained and chopped
- 1 bay leaf
- ¼ tsp thyme
- grated zest of ½ orange
- pinch of saffron (optional)
- 1 large clove garlic, crushed
- salt and pepper

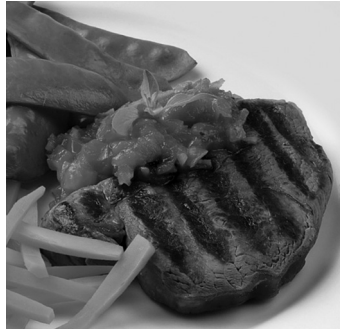

Sauté the onions in a pan till they're just translucent. Add the tomatoes, then the other concasse ingredients, and simmer, stirring occasionally, till the concasse is thick and rich.

Preheat the grill.

Trim the fillets, then flatten gently. Cut the garlic clove in half, and rub the cut side over the surfaces of the fillets.

Lay the fillets on the grill, and cook for 2-5 minutes, depending on how rare you want them.

★ Remember – it's fillet steak – it doesn't take a lot of cooking!

Put a portion of concasse on a plate, lay a steak on top, then pour a little more concasse over it.

Accompany with creamy mashed potatoes, boiled baby new potatoes in butter, carrot sticks and a green vegetable.

chicko caramba

serves 3-4

- 3-4 tortilla wraps
- 500g skinless chicken breast fillets
- shredded lettuce
- tomato slices
- avocado slices
- spring onions, shredded lengthwise
- little salt and pepper
- fresh coriander leaves



marinade

- 4 tbsp olive oil
- juice of 1 lime or lemon
- 2 tbsp hot chilli sauce
- $\frac{3}{4}$ tsp ground cumin
- 1 clove garlic, crushed

Trim any fat from the fillets, then cut each fillet in half lengthways. Mix the marinade, add the fillets, turning to coat them, cover, and chill for at least an hour, turning every half hour or so. Preheat the grill, lay the chicken fillets on the grill plate, and grill till cooked (8-10 minutes). Remove the chicken, cover, and rest for 10 minutes.

Meantime, wipe the grill plates, warm the tortillas, remove from the heat, and turn the grill off. Pile lettuce, tomato, avocado, and spring onions on each tortilla, sprinkle with salt and pepper, lay a chicken fillet on top, fold the bottom of the tortilla up, over the chicken, then fold in the sides of the tortilla, to form an envelope, and serve.

Asian chicken burger

serves 4

- 450g lean minced chicken
- 2 spring onions, finely chopped
- 2 tbsp soy sauce
- 1 egg white
- 1 clove garlic, finely chopped
- 1 tbsp lemon juice
- $\frac{1}{2}$ tsp ground ginger

Combine everything, shape into 4 burgers, and refrigerate for 2 hours. Grill the burgers for 5 minutes, then check for readiness.

Tex-Mex burger

serves 4

- 450g lean minced beef
- 1 strong onion, finely chopped
- 1 tsp chilli powder
- 2 tbsp barbecue sauce
- 1 tbsp fresh salsa

Combine everything, shape into 4 burgers, grill for 4 minutes, then check for readiness.

cheese and horseradish burger

serves 4

- 450g lean minced beef
- 2 tbsp creamed horseradish sauce
- $\frac{1}{2}$ tsp black pepper
- 125g low fat Cheddar cheese, grated
- $\frac{1}{2}$ tsp garlic powder
- $\frac{1}{2}$ tsp sea salt

Combine everything, shape into 4 burgers, grill for 4 minutes, then check for readiness.

ranchero burgers

serves 4

- 375g lean minced beef
- 2 cloves garlic, finely chopped
- $\frac{1}{2}$ tsp black pepper
- 125g tinned kidney beans, drained and mashed
- 4 tbsp barbecue sauce
- $\frac{1}{2}$ tsp sea salt

Combine everything, shape into 4 burgers, grill for 4 minutes, then check for readiness.

pineapple teriyaki burger

serves 4

- 450g lean minced chicken
- 4 tbsp bottled teriyaki sauce
- 1 tsp yellow mustard
- 4 slices fresh pineapple
- 1 egg white
- 1 strong onion, finely chopped
- $\frac{1}{2}$ tsp black pepper

Refrigerate the pineapple slices. Combine the other ingredients, and shape into 4 burgers. Grill the burgers for 4 minutes, then check for readiness. Put a slice of pineapple on each burger.

cheesy beef burger

serves 4

- 450g lean minced beef
- 1 spring onion, chopped
- $\frac{1}{2}$ tsp garlic powder
- 1 tsp sea salt
- 250g low fat Cheddar cheese, grated
- 1 tbsp Worcestershire sauce
- $\frac{1}{2}$ tsp black pepper

Combine everything, shape into 4 burgers, grill for 4 minutes, then check for readiness.

ranch style chicken burger**serves 4**

450g lean minced chicken
 1 tbsp coriander leaves, finely chopped
 ½ tsp Tabasco sauce
 ¼ tsp garlic powder
 2 tbsp canned green chillies, chopped
 2 tbsp mayonnaise
 ½ tsp black pepper

Combine everything, shape into 4 burgers, grill for 5 minutes, then check for readiness.

Swiss turkey burger**serves 4**

450g lean minced turkey
 1 egg white
 ¼ cup fresh breadcrumbs
 1 tsp sea salt
 200g low fat Swiss cheese, grated
 1 tbsp Dijon mustard
 1 tsp black pepper

Combine everything, shape into 4 burgers, grill for 7 minutes, then check for readiness.

lamb burger**serves 4**

450g lean minced lamb
 ½ tsp dried rosemary, ground
 1 red onion, thinly sliced
 ¼ cucumber, thinly sliced
 ½ tsp black pepper
 ½ tsp sea salt
 2 tomatoes, thinly sliced
 4 soft pitta breads

Combine the lamb, rosemary, pepper, and salt, and shape into 4 burgers. Grill the burgers for 6 minutes, then check for readiness. Warm the pitta breads, and open them to form pockets. Fill each pitta pocket with a burger, and a selection of onion, tomato, and cucumber slices.

portabella mushroom burger**serves 4**

4 large portabella mushrooms
 2 tbsp extra virgin olive oil
 1 tbsp dried Italian seasoning
 2 cloves garlic, finely chopped
 2 tbsp balsamic vinegar
 1 tsp black pepper

Remove the stems from the mushrooms. Lay the mushrooms, underside up, on a hot grill.

Drizzle the oil and vinegar over the mushrooms, then sprinkle with the garlic, italian seasoning, and pepper. Close the grill, and grill for 5 minutes.

Dijon pork burgers**serves 4**

450g lean minced pork
 2 tbsp Dijon mustard
 1 tsp black pepper
 1 strong onion, chopped
 2 tbsp mayonnaise
 ½ tsp sea salt

Combine everything, shape into 4 burgers, grill for 7 minutes, then check for readiness.

cowboy burger**serves 4**

450g lean minced beef
 1 strong onion, finely chopped
 1 tbsp brown sugar
 1 tbsp yellow mustard
 1 clove garlic, finely chopped
 2 tbsp Worcestershire sauce
 4 tbsp tomato ketchup

Simmer the tomato ketchup, mustard, sugar, Worcestershire sauce, onion and garlic in a pan for 10 minutes, then let the sauce go cold. Mix the beef with the cold sauce. Shape the mixture into 4 burgers and refrigerate for 2 hours. Grill the burgers for 5 minutes, then check for readiness.

George Foreman's PowerBurger**serves 4**

375g lean minced beef
 4 tbsp chopped vegetables – onions, spring onions, courgettes, parsley (these can be sautéed)
 4 tbsp seasoned breadcrumbs

Combine the vegetables and breadcrumbs in a bowl. Add the minced beef and mix well. Shape the mixture into 4 10cm wide burgers. Preheat the grill and cook for 5-6 minutes, or till the meat is no longer pink and the juices run clear, turning once. This recipe is from The healthy Gourmet (Clarkson Potter) by Cherie Calbom.

top plate and deep dish (grill flat)

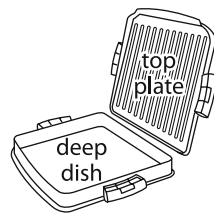

pizza dough (2-3 pizzas)

- 500g strong white flour (or 400g strong flour and 100g fine semolina)
- 250ml lukewarm water
- 1½ tsp dried yeast
- 1½ tbsp olive oil
- 1½ tsp sugar
- 1½ tsp salt

Use setting 200.

Sift the flour into a bowl and add the yeast, sugar and salt. Add the water and oil and mix till the dough is fully incorporated and smooth in texture. Cover the bowl with a damp tea towel or cling film and let it rest in a warm place for about half an hour.

Remove the dough and knead by hand for a few minutes.

Cut the dough in half, roll one of the halves out on a floured surface, and cut to fit the flat plate (280 x 160mm or 11 x 6¼"). Lay the pizza base on the flat plate, close the lid, and cook for 5 minutes, to firm the base. Open the lid, and spread the pizza base thinly with a tomato based sauce, then top with your favourite toppings (ham, cheese, sweetcorn, peppers, mushrooms, onions, pepperoni etc.) – don't overload the pizza with toppings, you'll make it soggy. Close the lid, and cook for a further 12-15 minutes, till the edges of the crust are golden brown. Check that all parts of the topping are cooked through and fit to eat. You may have enough dough left over for a third pizza, depending on how thinly you roll the dough.

smoked haddock fishcakes

6 cakes/serves 2

- 200g smoked haddock fillet
- 220g potatoes, peeled and quartered
- 4 spring onions, finely chopped
- 1 handful fresh parsley, chopped
- 1 medium egg
- 1 tsp Dijon mustard
- 1 tbsp milk
- 1 tbsp vegetable oil
- pinch pepper and nutmeg

Use setting 200.

Boil the potatoes in lightly salted water till soft, drain, and mash. Poach the fish in a pan. When the flesh becomes opaque, flake the fish, and discard the skin. Mix the fish, spring onions, Dijon mustard, fresh parsley, milk, egg, pepper and nutmeg with the mashed potatoes.

Brush the top plate lightly with oil, then pour the rest of the oil into the flat plate.

Divide the mixture into 6 portions, roll each into a ball, then flatten into cakes. Lay the cakes on the flat plate with a plastic spatula. Close the lid, and cook for 4 minutes. Open the lid, turn the fishcakes with a plastic spatula, close the lid, and cook for a further 4 minutes.

plain omelette

serves 3-6

- 5 medium eggs
- 3 knobs butter
- 4 tsp water
- pinch salt and pepper

Use setting 170.

Beat the eggs in a jug, then beat in the water, salt and pepper. Put a knob of butter in the flat plate and let it melt. Pour in the egg mixture, close the lid, and cook for 9 minutes.

cheese & ham omelette

serves 3-6

- 4 medium eggs
- 70g ham, roughly chopped
- 50g grated cheddar cheese
- 3 knobs butter
- 4 tsp water
- pinch salt and pepper

Use setting 170.

Beat the eggs in a jug and mix in the water, ham, cheese, salt and pepper. Put a knob of butter in the flat plate and let it melt. Pour in the egg mixture, close the lid, and cook for 9 minutes.

French toast (eggy bread)

2 slices

- 2 medium eggs
- 2 slices bread
- 60ml milk
- 1 tbsp vegetable oil
- pinch salt and pepper

Use setting 200.

Beat the eggs in a bowl, then beat in the milk, salt and pepper. Coat both sides of each slice of bread with the mixture. Brush the top plate lightly with oil, then pour the rest of the oil into the flat plate. Lay both slices of bread on the flat plate, close the lid, and cook for 4 minutes. Open the lid, turn the bread with a plastic spatula, close the lid, and cook for a further 4 minutes.

pancakes

2-3 pancakes

- 1 medium egg
- 40g plain flour
- 200ml milk
- 3 knobs butter
- pinch salt

Use setting 200.

Put the flour in a bowl and make a well in the centre. Put the egg, milk and salt into the well and slowly combine with the flour. When combined, beat with a wooden spoon till it's free of lumps. Put a knob of butter in the flat plate and let it melt. Pour in enough batter to cover the bottom, close the lid, and cook for 3 minutes. Open the lid, turn the pancake with a plastic spatula, close the lid, and cook for a further 3 minutes.

Yorkshire pudding

serves 2-4

- 1 medium egg
- 75g plain flour
- 75ml milk
- 3 knobs dripping or lard
- 55ml water
- pinch salt and pepper

Use setting 200.

Put the flour in a bowl and make a well in the centre. Put the egg, milk, water, salt and pepper into the well and slowly combine with the flour. When combined, beat with a wooden spoon till it's free of lumps. Put a knob of dripping or lard in the flat plate and let it melt. Pour in the batter, close the lid and cook for 10 minutes.



ENVIRONMENTAL PROTECTION

To avoid environmental and health problems due to hazardous substances in electrical and electronic goods, appliances marked with this symbol mustn't be disposed of with unsorted municipal waste, but recovered, reused, or recycled.



SERVICE

If you ring Customer Service, please have the **Model No.** to hand, as we won't be able to help you without it. It's on the rating plate (usually underneath the product).

The product isn't user-serviceable. If it's not working, read the instructions, check the plug fuse and main fuse/circuit breaker. If it's still not working, consult your retailer.

If that doesn't solve the problem – ring Customer Service – they may be able to offer technical advice.

If they advise you to return the product to us, pack it carefully, include a note with your name, address, day phone number, and what's wrong. If under guarantee, say where and when purchased, and include proof of purchase (till receipt). Send it to:

Customer Service

Spectrum Brands (UK) Ltd

Fir Street, Failsworth, Manchester M35 0HS

email: support@georgeforeman.co.uk

telephone: 0845 658 9700 (local rate number)

➔ GUARANTEE

Defects affecting product functionality appearing within two years of first retail purchase will be corrected by replacement or repair provided the product is used and maintained in accordance with the instructions. Your statutory rights are not affected. Documentation, packaging, and product specifications may change without notice.



ONLINE/SPARES

www.georgeforemangrills.co.uk for more products and/or spares



REGISTER ONLINE FOR –

 £10,000 prize draw,

 EXTRA year guarantee,

 FREE rewards gallery

Visit www.productregister.co.uk/george

You must register within 28 days of purchase.